

PDS_251

VENTOLINO



MANUAL : MA
SALESSTATUS : STD
PRODUCT DIMENSIONS : 335 x 78 x 80 mm

MATERIAL :

**EN ventolino**

- injection moulded
- swinging whilst rotating
- ring and eight in galvanised steel
- black PP welds on the rope

NL ventolino

- spuitgegoten
- schommelen en roteren tegelijk
- ophanging en stelacht in gegalvaniseerd staal
- zwarte PP kunststof lassen als touwverbinding

FR ventolino

- moulé par injection
- se balancer en tournant autour de son axe
- anneau de suspension et huit de réglage en acier galvanisé
- surmoulages en PP couleur noir

DE ventolino

- Spritzguss
- Schaukeln und drehen
- Ring und Stellacht aus verzinktem Stahl
- schwarze Seilverbindungen aus PP







ES ventolino

- inyectado
- permite rotación durante el balanceo
- anillo de suspensión y ocho de ajuste de acero galvanizado
- soldaduras de PP color negro

PL ventolino

- formowany metodą wtryskową
- huśtanie połączone z obracaniem się
- kółka oraz ousemki ze stali galwanizowanej
- czarne zgrzewy PP na linach

PACKAGING

				
251.	0,40 kg	10	47 x 36 x 20 cm	6 kg
				
251.	45		120 x 80 x 190 cm	285 kg



KBT nv
Hemelrijken 8
2890 Sint-Amands
Belgium

KBT Polska sp. z o.o.
ul. M. Konopnickiej 6
00-491 Warszawa
Poland

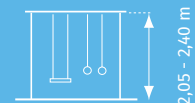

VENTOLINO

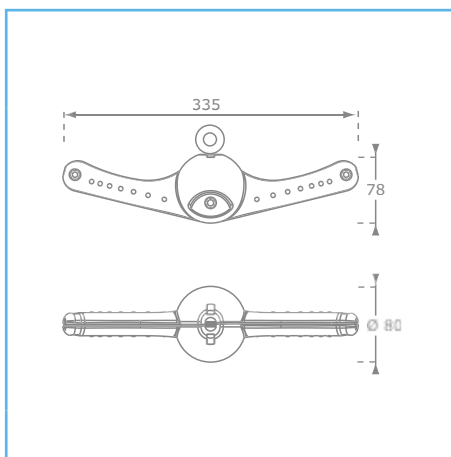

DRAWINGS:



VARIATIONS :

-  251.003.001.001 ventolino' - PH - red
-  251.003.002.001 ventolino' - PH - green
-  251.003.007.001 ventolino' - PH - lime green